

Luminance Colorimeter

# ***BM-7AC***

**It was realized in about 0.5 seconds quantitative evaluation that is for luminance, chromaticity, correlated color temperature, etc. in mass production line.**

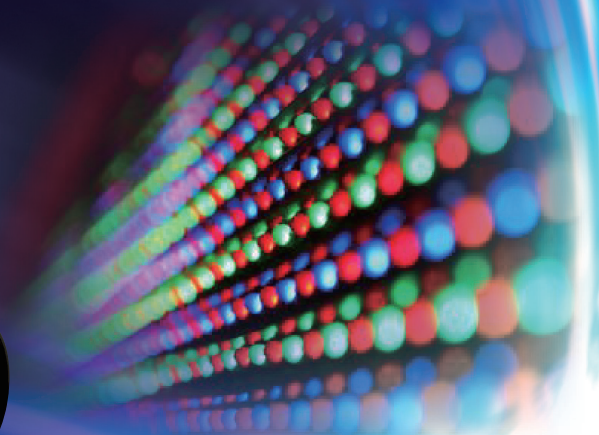
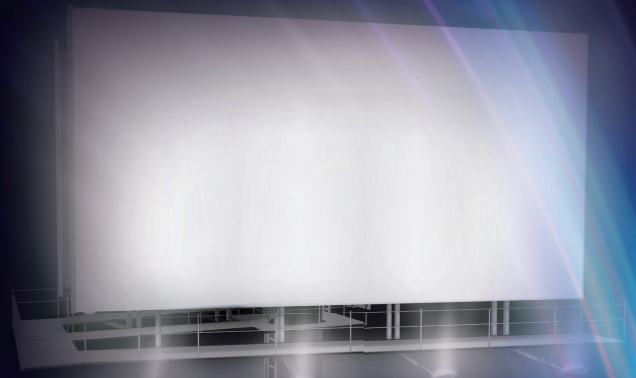

# It was realized measurement speed that can be used in production line.

## Luminance Colorimeter **BM-7AC**



### ·Main Applications for BM-7AC

Optical property evaluation for flat panel displays, luminance / chromaticity / color temperature measurement for lamps and other light sources.



FPD

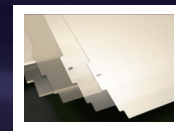

Optical film



LED backlight



Stop lamp



License lamp



LED

### Features

#### Point.1 Delivers high-speed measurement

Measurement speed of just 0.5 seconds. Ideal for in-line measurement in mass production settings.

#### Point.2 High durability

This model has filter of non-rotational structure, so that it has excellent durability.

#### Point.3 Luminance accuracy

Delivers luminance accuracy within  $\pm 2\%$  (for Standard source A, measurement angle  $2^\circ$ , luminance  $5\text{cd/m}^2$  or above, Auto Range)

#### Point.4 Auto mode measurement

Auto mode automatically sets the measurement range according to the brightness of the target.

#### Point.5 Internal interfaces

Dual interface options:  
USB and RS-232C.



(This picture is analog output type.)

#### Point.6 Analog output Custom-made product. BM-7AC ANA

Optional three-channel analog output to X, Y and Z channels for recording and waveform observation using a recorder or oscilloscope.

Example)

Rise and fall response characteristics, frequency, etc. of a flashing light source.

	FAST		
	X	Y	Z
1	30ms	30ms	30ms
2	30ms	30ms	30ms
3	30ms	30ms	30ms
4	0.3ms	0.3ms	0.3ms
5	0.3ms	0.3ms	0.3ms

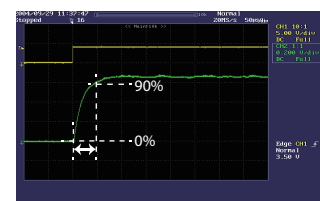

\*The response speed in the table above is the time that it takes analog output from the instrument to reach 90% of the peak value, when measuring an LED driven by a square wave from a function generator.

\*When observing a blinking light source using analog output, set the speed to the FAST mode.

-Output impedance is approximately  $100\Omega$ .

Recording instrument must have Input impedance of  $10\text{k}\Omega$  or above.

-Output voltage : 0 to 3.0V

•Chromaticity accuracy of the combination of standard light source A and our colored glass filter. (Reference)

$\Delta x, \Delta y : \pm 0.03$  or less (auto range, standard sources A)

# Low cost basic model that pursued stability.

## Standard accessories software supports control of instrument and data collection

### BM-7AC colorimetry software CS-900A(standard accessory)

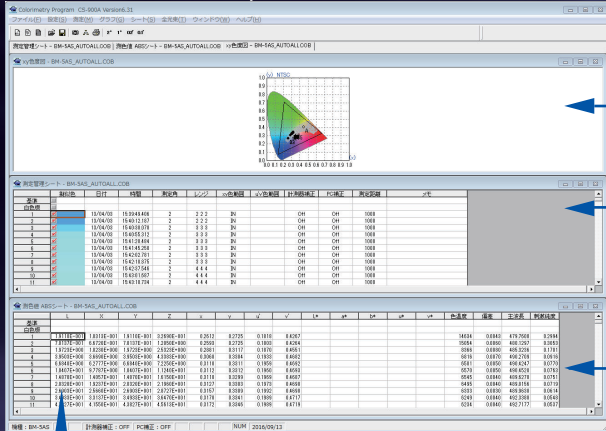

Application software CS-900A for Windows supports BM-7AC. You can control BM-7AC using by the CS-900A, and collect, save, plot on a graph and calculate of the measured data and, use them for many purpose. On the Colorimetry mode, it can shorten the communication time between the instrument and PC due to omitting spectral data transmission.

- xy chromaticity graph
- Colorimetry data
- Measurement conditions / note

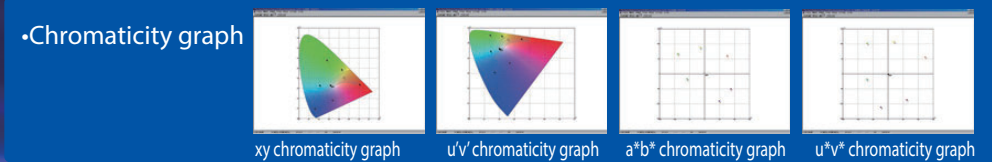

Color space mode: L, xy, XYZ, u'v', u\*v\*, L\*a\*b\*, Correlated color temperature, Deviation, Dominant wavelength, Chromaticity Statistics  
 Mode selection: AUTO: The measuring device determines optimum measuring range for each filter automatically. MANUAL: Use this mode to set common measurement range for among X,Y,Z manually.  
 Selects the measurement mode: Single / Interval / Continue  
 Color Range Setting: The software determines whether or not the measured color data fall within the specifid range in the color diagram.

System required (recommended)  
 •OS: Windows® 10 Pro or more (32bit/64bit)  
 Windows® 11 Pro or more (64bit)  
 •CPU: Intel® Core™ i3 2.4GHz or more  
 •HDD: 1GB or more  
 •Memory: 1GB or more  
 •Ports: USB2.0 (One port) / RS-232C serial port (One port)  
 \*The RS-232C cable (straight cable for DOS/V PC) must be purchased separately.

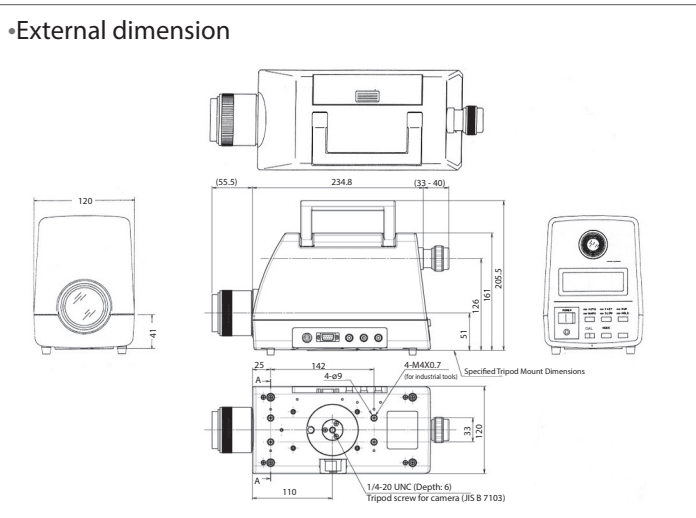
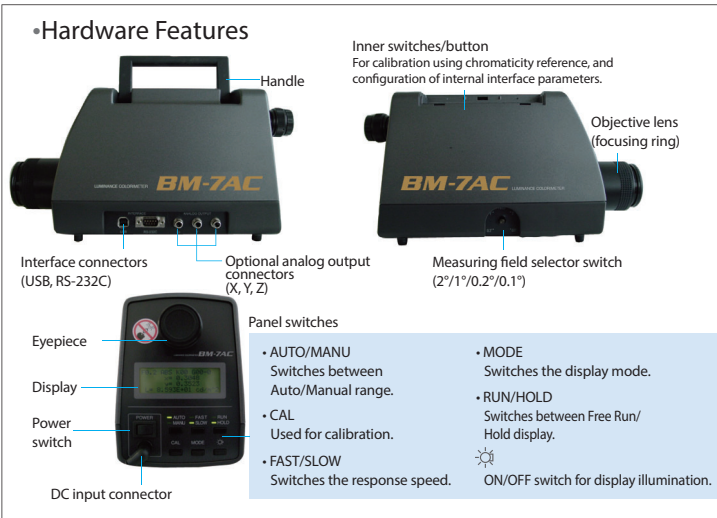
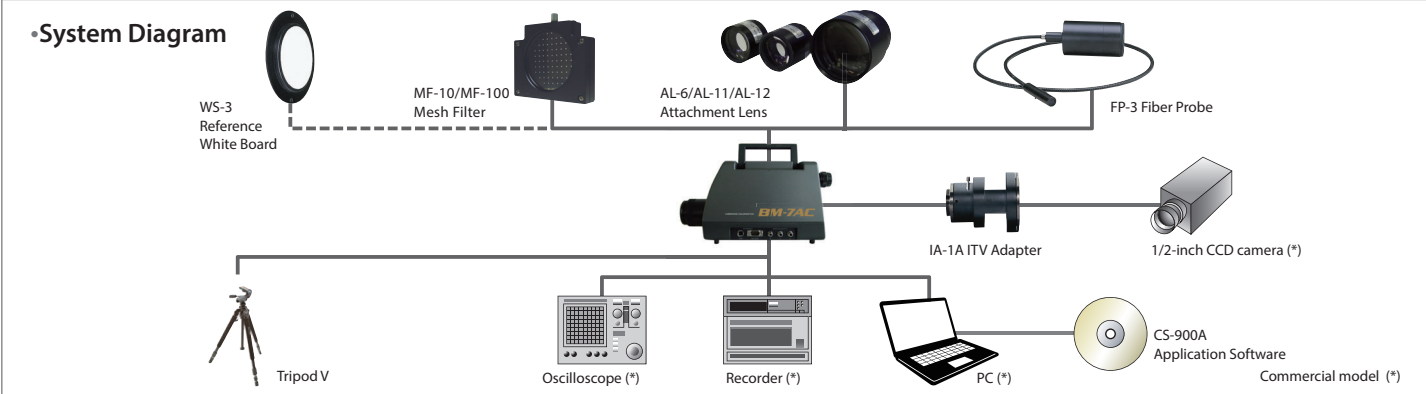

## Specifications

Optics	Objective lens : Focal distance $f = 80\text{mm}$ , F2.5 Eyepiece lens : 5° view field, $\pm 5$ diopter adjustment range					
Spectral response characteristic	Similar to CIE1931 color matching functions					
Photo cell	3-element silicon photodiode (X, Y, Z)					
Measurement angle	Selectable aperture of 2°, 1°, 0.2° and 0.1°					
Measurement distance	350 mm to $\infty$ (from front of objective lens)					
Measurement diameter (mm $\phi$ )	Measurement angle	Measurement distance (mm)				
		350	500	1000	5000	10000
	2°	10	15.4	32.8	169	341
	1°	5	7.7	16.4	85	170
	0.2°	1	1.5	3.3	17	34
	0.1°	0.5	0.8	1.6	8	17
Measurement functions	$x, y, L$ ( $x, y$ : chromaticity coordinates, $L$ : luminance) $\pm \Delta$ , $u', v', L(u', v', L$ : chromaticity coordinates, $L$ : luminance) $\pm \Delta$ $X, Y, Z$ ( $X, Y, Z$ : tristimulus values) $\pm \Delta$ , $T_c, \text{duv}$ , $L(T_c$ : correlated color temperature, $\text{duv}$ : deviation) $\pm \Delta$ CIE 1976 $L^*a^*b^*$ $\Delta E_{ab}^*$ $\pm \Delta$ , CIE 1976 $L^*u^*v^*$ $\Delta E_{uv}^*$ $\pm \Delta$ , CIE 1976 $L^*a^*b^*$ $\Delta E_{ab}^*$ $\pm \Delta$ , CIE 1976 $L^*u^*v^*$ $\Delta E_{uv}^*$ $\pm \Delta$					
Measurement range	Auto, Manual (5-step selectable)					
Measurement range (Not a guaranteed accuracy range)	0.01 to 12,000,000 $\text{cd/m}^2$					
Measurement range	Measurement angle	Measurement angle				
		2°	1°	0.2°	0.1°	
	Measurement range	Range 1	0.01 - 30	0.04 - 120	1 - 3,000	4 - 12,000
		Range 2	0.03 - 90	0.12 - 360	3 - 9,000	12 - 36,000
		Range 3	0.1 - 300	0.4 - 1,200	10 - 30,000	40 - 120,000
		Range 4	1 - 3,000	4 - 12,000	100 - 300,000	400 - 1,200,000
Range 5	10 - 30,000	40 - 120,000	1,000 - 3,000,000	4,000 - 12,000,000		
Accuracy *	◦ Luminance 1 : 1-5 $\text{cd/m}^2$ within $\pm 4\%$ (measurement angle 2° Auto Range) ◦ Luminance 2 : 5 $\text{cd/m}^2$ or above within $\pm 2\%$ (measurement angle 2° Auto Range) ◦ Chromaticity 1 : $dx, dy$ within $\pm 0.002$ (10 $\text{cd/m}^2$ or above)					
Repeatability (For standard source A)	◦ Luminance 1 : 1-5 $\text{cd/m}^2$ : 1% or less (measurement angle 2°, 2 $\alpha$ , SLOW mode, Auto Range) ◦ Luminance 2 : 5 $\text{cd/m}^2$ or above : 0.5% or less (measurement angle 2°, 2 $\alpha$ , SLOW mode, Auto Range) ◦ Chromaticity 1 : 1-5 $\text{cd/m}^2$ chromaticity $x, y$ : within 0.005 (measurement angle 2° SLOW mode, Auto Range) ◦ Chromaticity 2 : 5 $\text{cd/m}^2$ or above, chromaticity $x, y$ : within 0.002 (measurement angle 2° SLOW mode, Auto Range)					
Measurement time	Approx. 0.5 sec (FAST or SLOW)					
Display	Dot matrix LCD: 20 digits x 4 lines with illumination function					
Minimum luminance display	0.01 $\text{cd/m}^2$					
Interface	Selectable USB or RS-232C					
Power supply	Dedicated AC adapter (AC 100V to 240V, 50/60 Hz)					
Power consumption	Approx. 2.5VA					
Operating requirements	Temperature: 0 to 40°C Humidity: Below 85% RH (must be condensation free)					
Storage requirements	Temperature: -20 to 60°C Humidity: Below 85% RH (must be condensation free)					
External dimensions	Approx. 325 x 120 x 162 mm (L x W x H)					
Weight	Approx. 3 kg (main unit only)					

\*The precision value (luminance and chromaticity) written in this catalog is the specification value by our standard light source and measurement condition.  
 \*Due to the nature of the product, measurement error that is out of specification value may occur by the difference of the light source, measurement condition and measurement environment.

## BM-7AC Standard Package

- BM-7AC Luminance Colorimeter ..... 1ea.
- AC adapter ..... 1ea.
- Objective lens cap ..... 1ea.
- Eyepiece lens cap ..... 1ea.
- CD-ROM (colorimetry software CS-900A / Instruction manual) ..... 1ea.
- Quick Manual ..... 1ea.
- Analog output plug ..... 3ea.

\* For analogue output model only

\* Carrying case is separate.



\* Some screens are simulated.  
 \* The specifications and external appearances of product in this catalogue may be changed without prior notice due to improvements.  
 \* The catalogue includes products that are sold separately.  
 \* The actual color of products may differ slightly from the catalogue due to lighting and printing conditions.

## TechnoOptis Co., Ltd.

Formerly Topcon Technohouse Corporation

4F, Imas Itabashi BASE, 2-4-1, Sakashita, Itabashi-ku, TOKYO, 174-0043 JAPAN

Phone: +81-3-3558-2666 Fax: +81-3-3558-4661

E-mail: techno-info@techno-optis.com

### SAFETY PRECAUTIONS



Make sure to carefully read the "Manual" to ensure that you use the product properly and safely.  
 • Always connect the instrument to the specified power supply voltage. Improper connection may cause a fire or electric shock.

## Optional Accessories



### AL-6 / AL-11 / AL-12 Attachment Lens

Attaches to the objective lens on the BM-7AS unit. Shortens the focal distance and shrinks the minimum measurement area for measurement of small objects.

(Specifications for Measuring Small Objects)

Measurement diameter (mm $\phi$ )	Measurement angle	AL-6	AL-11	AL-12
		(measurement distance: 52 to 67mm)	(measurement distance: 20.4 to 24.8mm)	(measurement distance: 165 to 197mm)
2°		1.98 to 2.75	1.22 to 1.49	3.11 to 3.97
1°		0.99 to 1.37	0.61 to 0.74	1.56 to 1.99
0.2°		0.20 to 0.27	0.12 to 0.15	0.31 to 0.40
0.1°		0.10 to 0.13	0.06 to 0.07	0.16 to 0.20

\*Measurement distance may differ slightly depending on aperture mirror machining accuracy.

\*Measurement distance is from metal tip of attachment lens.



### WS-3 Reference White Board

Used for measurement of object color or light source with directionality.

- Luminance factor: 90% or above (Incidence 0°, Observation 45°)
- Material: Barium sulfate (BaSO<sub>4</sub>)
- Dimensions: 78 mm $\phi$ ,  $t = 12.5$  mm
- Effective white surface: 40 mm  $\phi$  (at center)

### FP-3 Fiber Probe



Light guide used for remote detection of light from measurement object.

- Effective measurement angle: 2°
- Measurement diameter: 3-10 mm $\phi$
- Measurement distance: 31.0-84.9 mm
- Fiber length: Approx. 1m

### IA-1A ITV Adapter



Adapter for connecting BM-7AS to CCD camera.

### MF-10 / MF-100 Mesh Filter

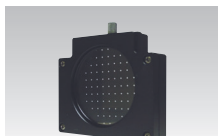

Mesh type filter for measuring objects with brightness exceeding measurement range of BM-7AS.

### Tripod 5N



Simplifies collimation of measurement object.

- Max. height: 1835 mm
- Min. height: 585 mm
- Folded length: 810 mm
- Leg sections: 3
- Weight: 4.8 kg (with pan head)

### Carrying Case

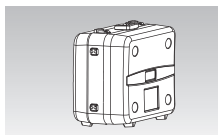

Convenient carrying case for transport or storage when not in use.

For more information please visit our website.

<https://www.techno-optis.com/en/>

