

Spectroradiometer

SR-5 SERIES

***Pursuing HDR, High speed, and Usability.
The new generation SR series
Spec up model added***



**High Dynamic Range about 15 billion:1
by full redesigning the optical system**

Completely renewal of spectroradiometer SR series

Proudly present state-of art spectroradiometer SR-5 series!



HDR(High Dynamic Range)Measurement

Dynamic Range 15 billion : 1 *SR-5AS Measurement angle 1°, Standard illuminant A
High dynamic range can be measured Ultra-low to Ultra-high luminance without using an external ND filter.

Ultra-low luminance measurement

SR-5AS supports from 0.0001 cd/m² at measurement angle 2° and accuracy is ±2%, and SR-5A supports ultra-low luminance measurement from 0.0005 cd/m² at measurement angle 2° and 1°.

SR-5AS and SR-5A suit the black level of VESA Display HDR True Black measured from 0.0005 cd/m² at measurement angle 1°

Ultra-high luminance measurement

SR-5AS and SR-5A support to 4,500,000 cd/m² at measurement angle 1°. The maximum range of high luminance is extended to 500,000,000 cd/m².

Measurement angle	SR-5AS *	SR-5A	SR-5S / SR-5
2°	0.0001 - 1,500,000 cd/m ²	0.0005 - 1,500,000 cd/m ²	0.001 - 15,000 cd/m ²
1°	0.0003 - 4,500,000 cd/m ²	0.0005 - 4,500,000 cd/m ²	0.003 - 45,000 cd/m ²
0.2°	0.01 - 100,000,000 cd/m ²	0.0125 - 100,000,000 cd/m ²	0.075 - 125,000 cd/m ²
0.1°	0.03 - 500,000,000 cd/m ²	0.05 - 500,000,000 cd/m ²	0.3 - 500,000 cd/m ²

*SR-5AS is custom-made model

High accuracy Luminance and Chromaticity

Luminance accuracy: within ± 2%, chromaticity accuracy: within dx ± 0.0015, dy ± 0.001.

*SR-5A Measurement angle 2°, NORMAL SPEED mode, Standard illuminant A

SR-5S with improved chromaticity accuracy from SR-5 (chromaticity accuracy: within dx±0.0015, dy±0.001).

High stability at low luminance

Repeat stability of luminance at 0.0001cd/m² : 1.34%

※SR-5AS Measurement angle 2°, 2σ from 10 times continuous measurement, NORMAL SPEED mode, Standard illuminant A, Average value from multiple units in TechnoOptis

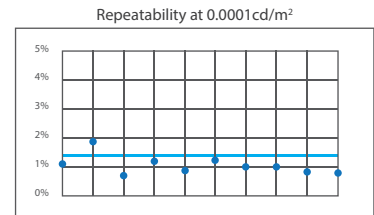

High Speed Measuring

The speed of product development and evaluation has been improved by significantly reducing the measurement time. It can also be used on production lines because it can be inspected quickly.

Significant reduction in measurement time

The measurement time has been significantly reduced by improving the sensitivity and internal algorithm based on renewing the optical system.

● Standard illuminant A : 0.0005cd/m²
SR-5A : at measurement angle 1°, SR-LEDW : at measurement angle 2°

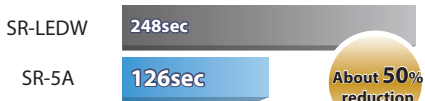

SR-5A's measurement speed is same at measurement angle 1° and 2°

Macimum integral time setting function

Added a function to set the maximum integral time to the Auto mode, which set optimal integral time set according to the brightness of the light source. It is effective in order to set the upper limit of the integral time and shorten the measurement time when measuring in low luminance status.

High speed mode

High speed measurement by applying a special sequence.

● Standard illuminant A : 0.0005cd/m²
SR-5A : at measurement angle 1°, SR-LEDW : at measurement angle 2°

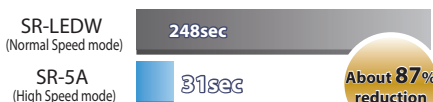

Communication time reduction

Supported by USB3.0.

High-speed communication is possible by improving the communication speed of RS-232C from the existing models. (38,400 bps→115,200 bps)

● RS-232C communication time

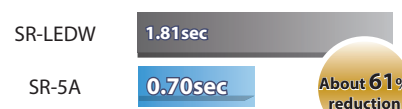

TechnoOptis Spectroradiometers SR series has always been the top model in the industry with cutting-edge optical technology such as mega-contrast and LED measurements.

The significantly renewed SR-5 series has improved measurement accuracy and pursued high-speed measurement.

It is a next-generation spectroradiometer with greatly improved usability by adopting a large-screen color touch panel display.



Usability improvement

Improved usability and visibility of measurement results by adopting a large screen color touch panel

Easy-to-read 4.3inch big size screen panel

The chromaticity diagram and spectral distribution can be displayed in color.

Easy operation by touch panel

Various settings can be done easily. Numerical values can be entered with the numeric keypad.

Various setting function

- Electric switching of measurement angle
- Electric open/close finder shutter
- Display items selectability
- Full color display the chromaticity diagram
- Full color display the spectrum distribution
- Dominant/peak wavelength can be displayed.

Main display

Measuring start button

Chromaticity diagram display

Spectrum distribution display

Electric switching of measurement angle

Display items selectability

Numerical values can be entered with the numeric keypad



Easy system installation

Easy system replacement by consolidating interfaces and standardizing communication commands and tool screws.

Rear interface

The interface is integrated on the back panel of the main unit with cable routing unified and flat side for system integration.

Downsizing the main body

The width of the main body is thinner than the conventional SR series : 150mm → SR-5 series : 130mm.

Environment information output

Temperature / humidity / acceleration speed information output for system environment management.

Compatibility with existing models

Same communication commands and tool setup screw positions with existing SR series enable easy transfer or update to the system.



Rear Interface layout

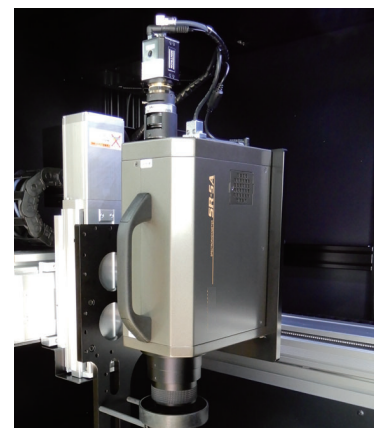

Tool and instrument setting image

▶ Other product features

■ Half band width is 5nm or less

Half band width is 5nm or less, which is required by colorimetry (JIS Z 8724-1997) in a visible light region.

■ High uniformity of the sensitivity on the measurement area

Uniformity of the sensitivity on the measuring area is within 5% in luminance at measuring angle of 1°.

■ Illuminance can be measured accurately

By installing an illuminance adapter (option) for illuminance measurement, accurate spectroscopic measurement of the illuminance and chromaticity of the irradiation light can be performed.

Complies with JIS C 1609-1: 2006 general type AA class illuminance meter.

■ FIX mode

Measurement time is faster about 1.5 sec than normal when measuring same kind of object in succession.

■ High accuracy measurement of flashing light

•Frequency measurement function

The optimal integral time and filter position are set according to the set frequency and brightness of the target.

•Integral time delay function

Periodic flashing light (PWM) sample can be measured stably.

•Synchronous measurement function

The instrument can detect and measure frequency of flash by inputting synchronous signal. Arbitrary frequency value can be set manually.

[Trigger condition] TTL level

Frequency : 12 - 750 Hz

Voltage : L level : 0 - 0.8V, H level : 2 - 5V

■ View angle of CIE Color matching function setting

Set the View angle of CIE color matching function for calculating chromaticity value.

View angle can be selected from 2° and 10°.

■ CIE 170-2 Color matching function

In addition to the current CIE 1931 color matching function, it corresponds the latest color matching function of the CIE 170-2: 2015 technical report.

Less visual color difference than CIE 1931 can be obtained in the filed of OLED, QD, BT2100 with laser, wide color gamut display of HDR.

Available to change field of view(2 degree or 10 degree) and

CIE(1931 or 170-2) using SR-5 series main unit,

or application software CS-900A that is standard accessory.

■ No need of warm-up after power on

Applies to
Measuring field : 2°

Luminance of object to be measured is 1cd/m² or above.

■ Option compatibility with existing models

Optional items for existing models such as attachment lenses and ND filters can use.

※ITV adapter is IA-1A.

■ High-speed measurement of small areas

With the measurement angle switching function of the main unit, according to the application, you can select the measurement angle of 2°, 1°, 0.2°, 0.1°.

The standard lens has a minimum measurement diameter of Φ 0.33mm, and if you use the optional attachment lens, you can measure even more Φ0.06mm.

Luminance and chromaticity can be measured at high speed and stably not only for general displays but also for small areas such as automotive instrument panels and indicators.

Example of using the integral time delay function with measuring PWM light

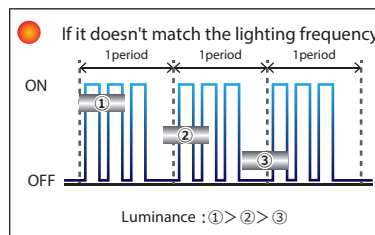

If the number of lightings included in the integration time is different, the measured value will vary.

It is necessary to set the integration time of the measuring instrument longer according to the lighting frequency, but it may be overranged for a light source with high brightness and high duty ratio.

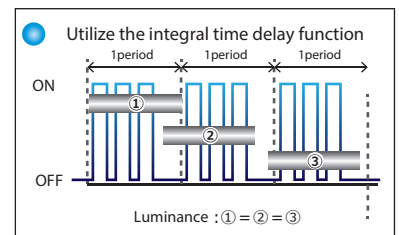

The integral time delay function of the SR-5 series sets a long integration time, so it is possible to suppress variations. In addition to frequency lighting light sources, it is also effective for PWM drive and passive matrix drive light sources.

2 degree viewing angle : High color gamut Display etc.

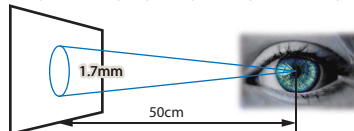

10 degree viewing angle : General Illumination etc.

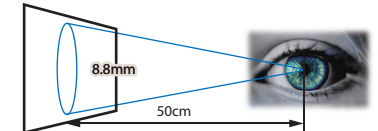

CIE 170-2:2015 Color matching function (2 degree viewing angle)

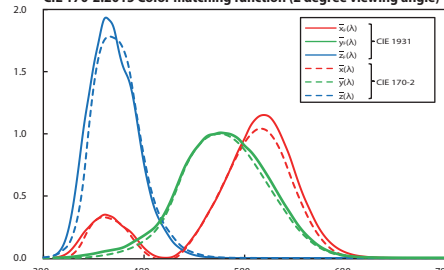

CIE 170-2:2015 Chromaticity Diagram (2 degree viewing angle)

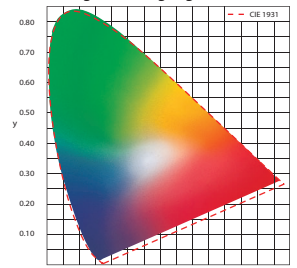

*Even if chromaticity is same due to difference of color range in chromaticity diagram, color tones are different in CIE1931 and CIE170.

► Colorimetry software CS-900A (Standard accessory)

Standard accessory software can control Spectroradiometer and can process measured data with simple operation.

The CS-900A for Windows can control the SR-5 series and collect, save, and graph measured data.

The measurement time can be shortened by selecting Colorimetry mode. In Colorimetry mode, the instrument will omit spectral radiance data and send the measured data of luminance, chromaticity, and color temperature.

* Judging the unevenness of LED color, classifying LED color into ANSI rank, and judging whether or not measured color data fall within certain rank.

* You can specify area in the color diagram and CS-900A judge whether or not color data fall within the area.

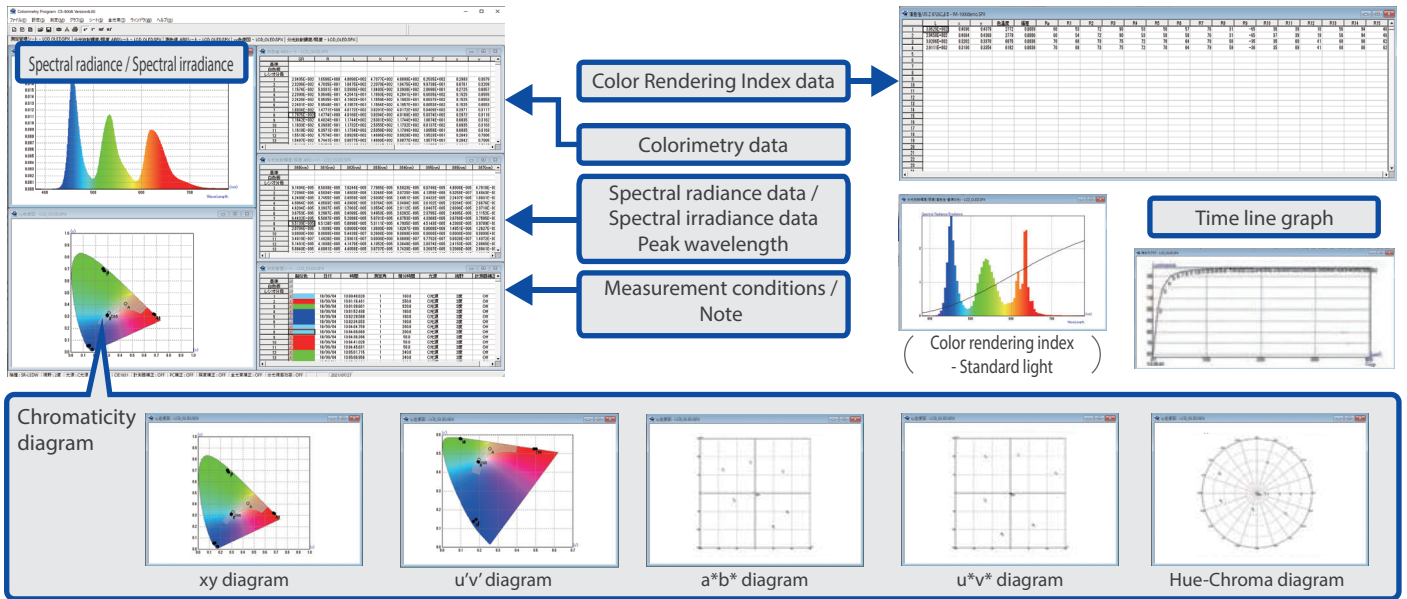

● Color rendering index (CRI)

Color rendering index is measure of how well light source render the color of object compared to reference light source. Ideal light source for CRI is rated as 100. Light sources with a high CRI are desirable. The lower the CRI rating, the less accurately colors will be reproduced.

test color samples

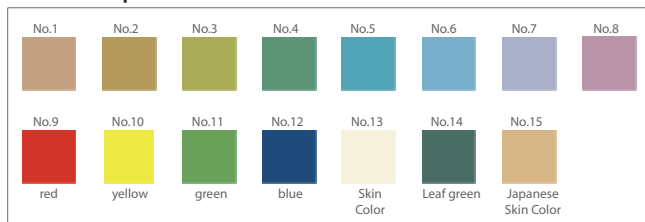

● Evaluation for Accessible design

Age-related luminance contrast, which is used in illumination and visual display design, can be evaluated complying with JIS S 0031.

- Evaluation items
- (1). Contrast ratio CR
 - (2). Weber ratio C_w
 - (3). Michelson contrast C_m

Evaluation based on Photopic and Scotopic are also available when entering their sensitivity data into software.



● This new Color Matching Function is corresponded to the latest CIE 170-2:2015 technical report.

Main functions

Display	: Spectral radiance graph, other graph
Color system	: Spectral radiance/Spectral irradiance(SR / SE), Radiance/ Irradiance(R / Ee), Candela(l), Luminance/Illuminance(L / Ev), Tristimulus value(XYZ), x,y, u',v', Color temperature, Deviation, Peak wavelength, Dominant wavelength, Excitation purity, Color rendering index
Function	: Fundamental operations of Spectral data
Mode	: Spectral mode, Colorimetry mode
Condition setting	: Auto, Frequency, Integral time, Integ. Delay mode, Measurement speed, Measurement angle, Average, Single, Interval, Continue,
Evaluation	: CIE standard observer, Light source, Color rendering index

Hardware requirement

■ OS	: Windows® 10 Pro or more (32bit / 64bit) Windows® 11 Pro or more (64bit)
■ CPU	: Intel® Core™ i3 2.4GHz or more <small>*In the 64bit, the CS-900A support amd 64 only.</small>
■ HDD	: 1GB or more
■ Memory	: 1GB or more
■ Port	: USB3.0 (1 pcs) RS-232C serial port (1 pcs)

*Use inter-link RS-232C cable for DOS/V.

*CS-900A communication speed become slower due to use hand-shake communication method.

This application software can be free download from our web site.
<https://www.techno-optis.com/en/download-cat/manual/>

Usage

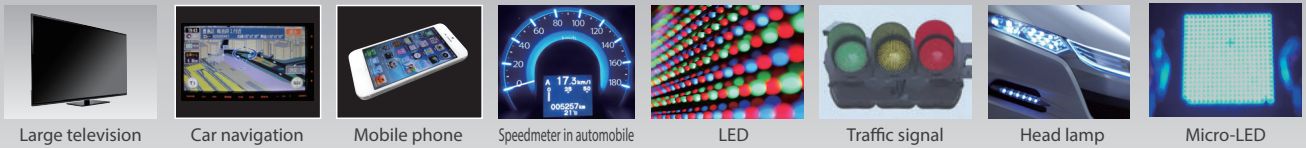

Optical characteristic evaluation of Flat Panel Display(LCD,OLED,QD,LD), Fluorescent material, Large Television, Mobile phone, Automobile (Component, Interior panel and various type of lamp), Indicator (Large Panel LED, Traffic light, mobile phone, AR/VR), Parts for display (LCD module, LED and Optical filter), Material (Back light, Fluorescent material, Optical filter, Organic EL, μ LED, MiniLED and QD), FPD(LCD·OLED·QD·LD),Production line(high precision gamma measurement with spectral measuring), R&D(various evaluation such as IVL-measuring), Others(Illumination lamp, Reflection light of painted surface or printing)

System Diagram

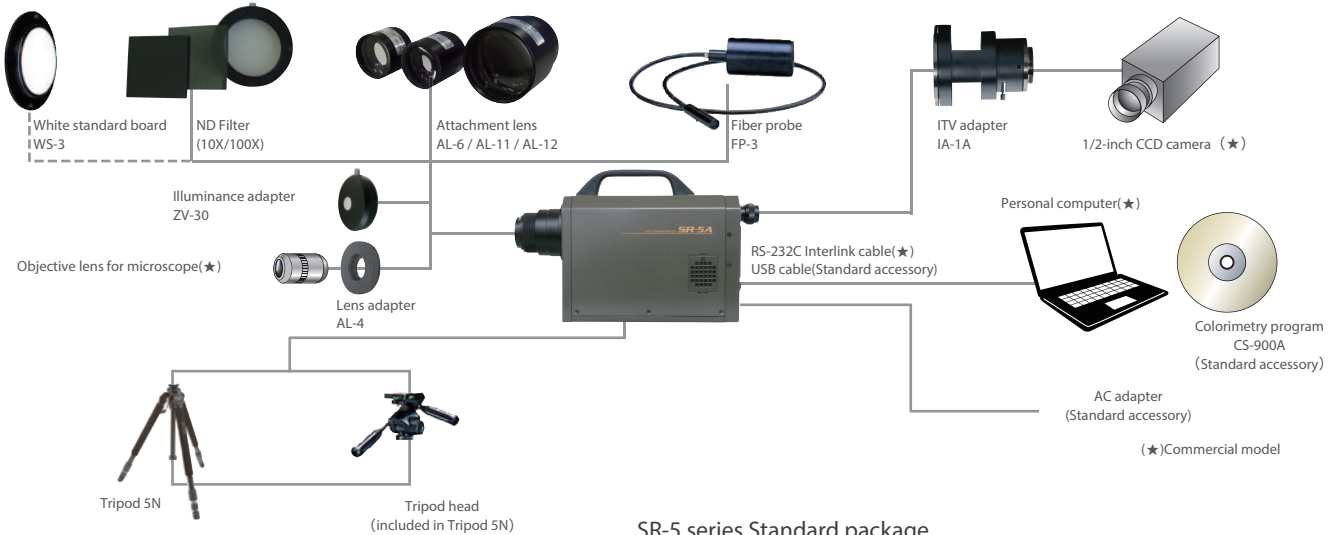

SR-5 series Standard package

- Main body 1ea.
- AC adapter 1ea.
- Carrying case 1ea.
- CD-ROM(Colorimetry software CS-900A / Instruction manual) 1ea.
- Quick manual 1ea.
- USB cable 1ea.
- Objective lens / Eye piece lens cap even 1ea.

Block diagram

Telescopic system makes it possible to measure the absolute value of the spectral radiance of light sources or objects without coming in contact with them. This optics also make it possible to verify the object to measure through a finder. SR-5A / SR-5 measurement time has been significantly reduced by improving the sensitivity and internal algorithm based on renewing the optical system.

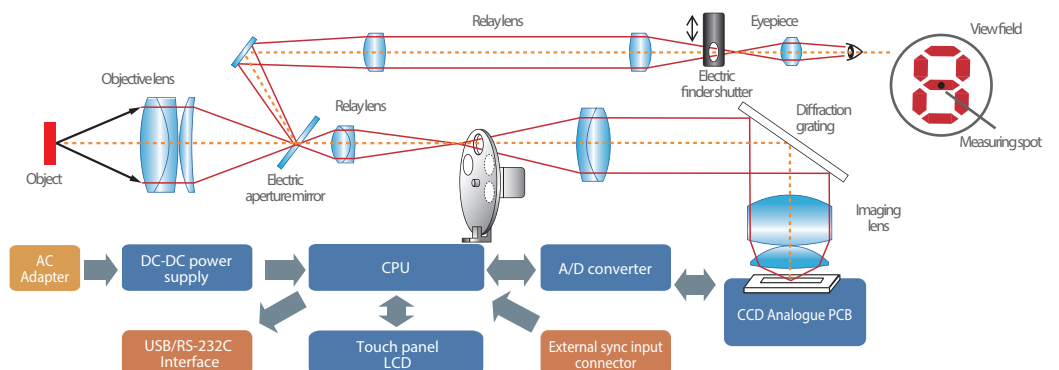

► Optional accessories

Measure the microsurface



● Attachment lens 3set AL-6 / AL-11 / AL-12

These lenses make focal length shorten and make measurement area shrink.

Measurement diameter (mm)	Measurement angle	AL-6	AL-11	AL-12
		(Measurement distance : 51.72 - 68.53mm)	(Measurement distance : 19.56 - 24.80mm)	(Measurement distance : 165 - 197mm)
	2°	2.00 - 2.88	1.18 - 1.53	3.23 - 4.00
	1°	1.00 - 1.44	0.59 - 0.76	1.62 - 2.00
	0.2°	0.20 - 0.29	0.12 - 0.15	0.32 - 0.40
	0.1°	0.10 - 0.14	0.06 - 0.08	0.16 - 0.20

*May change slightly according to the machining precision of the aperture mirror.

*The measurement distance is the distance from the tip of the metal fixture on the instrument of the objective lens.

Measure high luminance

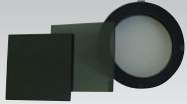

● ND filter(10x / 100x set)

Neutral density filter for measuring higher luminance than the measuring range of instrument.

	Measurement range(cd/m ²)					
	x10		x100			
SR-5AS	0.001	-	5,000,000,000	0.01	-	50,000,000,000
SR-5A	0.005	-	5,000,000,000	0.05	-	50,000,000,000
SR-5	0.01	-	5,000,000	0.1	-	50,000,000

Measure the illuminance



● Illuminance adapter (Cosine receptor) ZV-30

Complying with JIS C1609-1:2006 AA class
The spectral irradiance and illuminance may be measured by attaching an illuminance adapter to the Spectroradiometer.

*Calibration of your Spectroradiometer and Illuminance adapter is required in TechnoOptis factory before you use the illuminance adapter with your instrument.

• For measuring illuminance, chromaticity, color temperature, and color rendering index of light from LED, OLED illumination. For measuring illuminance of light from projector.

	Measurement angle	Measurement range(lx)		Accuracy (for standard illuminant A)	
				Illuminance	Chromaticity
SR-5A	2°	0.01	-	Ev : ±2%	x : ±0.0015 y : ±0.001
	0.1°	1.00	-		
SR-5	2°	0.02	-	Ev : ±2%	x,y : ±0.002
	0.1°	0.01	-		

Fix the luminance meter



● Tripod 5N

The tripod 5N make collimation easy.

- Max height : 1835mm
- Min height : 585mm
- Length when stored : 810mm
- Leg stages : 3steps
- Weight : 4.7kg with tripod head

Measure object color and directional light source



● White standard board WS-3

Uses when measuring object color and direction high directivity light.

- Luminance factor : 90% or less (Incidence 0°, Observation 45°)
- Material : Barium sulfate (BaSO₄)
- Dimension : ø78mm, t=12.5mm
- Effective white surface : ø40mm (Central portion)

Connect the CCD camera



● ITV adapter IA-1A

Adapter for connecting CCD camera (C mount, 1/2 inch) to the instrument.

Measure the light at a distance



● Fiber probe FP-3P

Light guide

- Effective measuring angle 2°
- Measurement diameter : ø3 to 10mm
- Measurement distance : 31.0 to 84.9mm
- Fiber length : about 1m

There are two types of fiber materials: plastic and quartz.

Connect a microscope objective lens



● The adapter for microscope AL-4

AL-4 is for connecting between the lens for microscope and objective lens of instrument.

It is possible to measure very small area using the lens for microscope.

► Dimensions

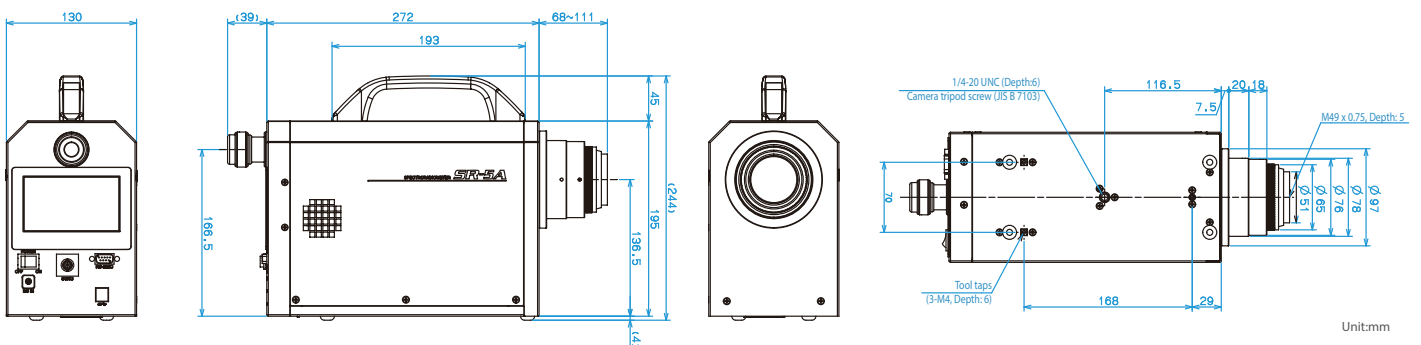

► Specification

Model		SR-5AS*	SR-5A	SR-5S	SR-5					
Optical system		Objective lens : f=82mm F2.5 / Eyepiece lens : Viewfinder visual field 5°、Diopter adjustment range ±5diopt								
Dispersion element		Diffraction grating								
Photo detector		Electronic cooling linear array sensor								
Measuring angle		2° / 1° / 0.2° / 0.1°								
Measuring distance		250 - ∞ (Distance from the objective lens hardware tip)								
Measuring diameter (mmø)	Measuring angle	Measuring distance (mm) (Distance from the objective lens hardware tip)								
		250	350	400	500	600	800	1000	2000	5000
	2°	6.5	10.0	11.7	15.1	18.6	25.4	32.2	66.4	169
	1°	3.25	4.99	5.84	7.55	9.26	12.7	16.1	33.2	84.4
	0.2°	0.65	1.00	1.17	1.51	1.86	2.54	3.22	6.64	16.9
	0.1°	0.33	0.50	0.59	0.76	0.93	1.27	1.61	3.32	8.44
Wavelength range		380 - 780nm								
Spectral accuracy		±0.3nm (on Hg emission line)								
Spectral band width		5nm or less (half width)								
Wavelength resolution		1nm								
Measurement mode		Auto , Manual (integral time / frequency) , Synchronous , FIX (integral time / frequency)								
Measuring object		Spectral radiance (W·sr ⁻¹ ·m ⁻² ·nm ⁻¹)								
Measuring function		Radiance (Le : W·sr ⁻¹ ·m ⁻²) , Luminance (Lv : cd·m ⁻²) , Tristimulus value XYZ, CIE 1931 chromaticity coordinates xy CIE 1976 chromaticity coordinates u'v' , Correlated color temperature (Tc : K) and deviation(duv) Dominance wavelength (nm), Peak wavelength (nm) CIE standard observer 2° / 10°								
Accuracy	Luminance*1	±2%								
	Chromaticity*1	Chromaticity x : ±0.0015、y : ±0.001 (2°: 0.0005cd/m ² -, 1°: 0.0015cd/m ² -, 0.2°: 0.0375cd/m ² -, 0.1°: 0.15cd/m ² -)	Chromaticity x : ±0.0015、y : ±0.001 (1°: 0.0015cd/m ² -, 0.2°: 0.0375cd/m ² -, 0.1°: 0.15cd/m ² -)	Chromaticity x : ±0.0015, y : ±0.001	Chromaticity x,y : ±0.002					
Repeat accuracy	Luminance *2	1.5% (0.0005 - 0.005cd/m ²) 0.4% (0.005 - 0.1cd/m ²) 0.3% (0.1cd/m ² -)		0.7% (0.001 - 0.1cd/m ²) 0.3% (0.1cd/m ² -)	1.5% (0.001 - 0.1cd/m ²) 0.3% (0.1cd/m ² -)					
	Chromaticity *3	0.005 (0.0005 - 0.005cd/m ²) 0.0015 (0.005 - 0.1cd/m ²) 0.0005 (0.1cd/m ² -)		0.005 (0.001 - 0.1cd/m ²) 0.0005 (0.1cd/m ² -)						
		Measuring luminance range (For standard illuminant A)	Measuring angle 2° 0.0001 - 1,500,000cd/m ² Measuring angle 1° 0.0003 - 4,500,000cd/m ² Measuring angle 0.2° 0.01 - 100,000,000cd/m ² Measuring angle 0.1° 0.03 - 500,000,000cd/m ²	0.0005 - 1,500,000cd/m ² 0.0005 - 4,500,000cd/m ² 0.0125 - 100,000,000cd/m ² 0.05 - 500,000,000cd/m ²	0.001 - 15,000cd/m ² 0.003 - 45,000cd/m ² 0.075 - 125,000cd/m ² 0.3 - 500,000cd/m ²					
Polarization characteristics		Luminance : 1% or less、Spectral radiance : 2% or less (400 - 780nm)								
Display		Touch panel LC(liquid crystal) display (LC size 4.3 type)								
Interface		RS-232C : Communication speed : 4800/9600/19200/38400/57600/115200bps、Data length : 7 / 8bits Parity : ODD/EVEN/NONE、Stop bit : 1/2bits USB : USB3.0								
Power supply		Exclusive AC adapter AC100V - 240V、50/60Hz、DC12V								
Power Consumption		Approx 30W								
Operating conditions		Temperature : 5 - 30°C		Temperature : 0 - 35°C						
External dimensions		Humidity : 80%R.H. or less (without dew condensation)								
Weight		Approx 422 × 130 × 244 mm Approx 5.5kg (Only the instrument body)								

*1 : Against standard illuminant A with Normal Speed mode.

*2 : 2σ from 10 times continuous measurement at measuring angle 2° in normal speed mode.

*3 : Max value - Min value from 10 times continuous measurement at measuring angle 2° in normal speed mode.

*SR-5AS is custom-made model.

*The measuring distance is the distance from the metallic tip of the objective lens.

*This values in this table design reference values and may differ somewhat from the actual diameter.



*Some screens are simulated.

*The specifications and external appearances of product in this catalogue may be changed without prior notice due to improvements.

*The catalogue includes products that are sold separately.

*The actual color of products may differ slightly from the catalogue due to lighting and printing conditions.

TechnoOptis Co., Ltd.

formerly Topcon Technohouse Corporation

4F, Imas Itabashi Base, 2-4-1, Sakashita, Itabashi-ku, Tokyo 174-0043 JAPAN

Phone: +81-3-3558-2666 Fax: +81-3-3558-4661

E-mail: techno-info@techno-optis.com

SAFETY PRECAUTIONS



Make sure to carefully read the "Manual" to ensure that you use the product properly and safely.
•Always connect the instrument to the specified power supply voltage. Improper connection may cause a fire or electric shock.

For more information please visit our website.



<https://www.techno-optis.com/en/>

©2021 TechnoOptis Co., Ltd.

Printed in Japan 2026 05 E12