

INDUSTRIAL UV CHECKER

UVR-T2

***Best to manage UV irradiation device Light intensity
adjustment replacing the lamp.***

Exposure
Liquid crystal
Bonding
Cleaning
Printing
Curing
Sterilization



Irradiance (mW/cm²)
Peak irradiance (mW/cm²)
Integral irradiance (mJ/cm²)

Improvement of usability and High-precision measurement of high-speed transport!

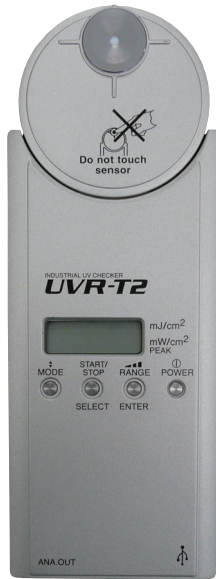

Metal body can be maintained a stable measurement. (equipped with heat shield)

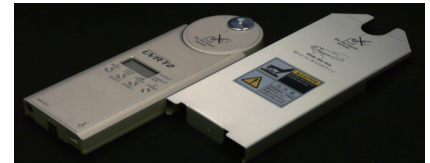
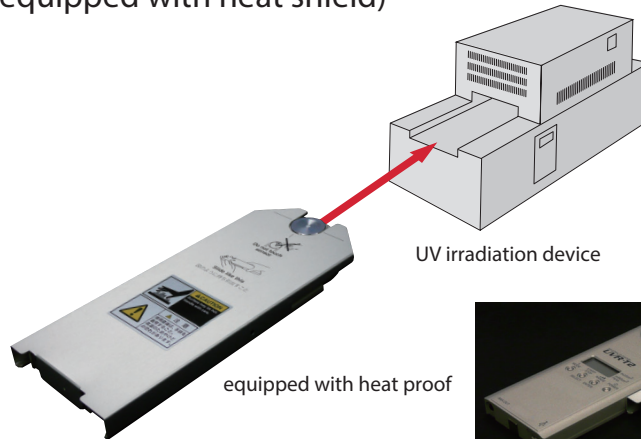

Industrial use UV checked UVR-T2 is ideal for management of UV irradiation equipment used at the Curing, and printing. Based on the measurement result of this product, a customer's improvement in the yield can be adjusted by using it for management of conveyor speed, or lamp intensity distribution and exchange time.

Applications

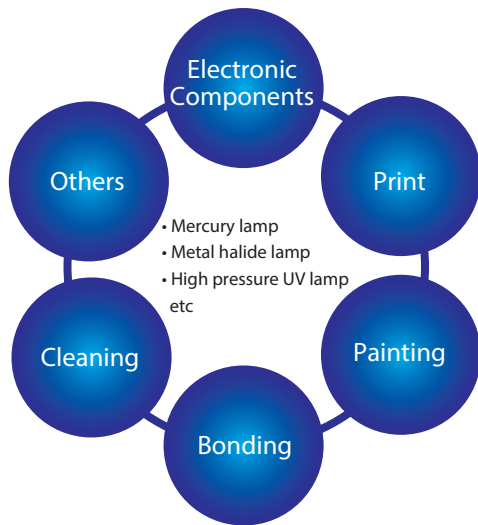

	applications
Electronics	Marking electronic parts
	Printed board manufacturing
Printing	Printing on seals and labels
	Printing on Plastic film
Coating	Printing paper
	Molded plastics
	Steel materials (antirust painting)
	CD and DVD for coating
Bonding	Adhering chips to printed boards
	Adhering glass products
	Adhering and sealing for LCDs and OLED
	Adhesion of resin moldings
Cleaning	Improved adhesion to the print
	Improve adhesion of the resin substrate and the cloth
Others	Seal material curing
	etc

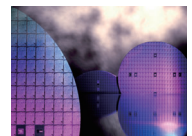

Features

Point

1 3 receiving elements

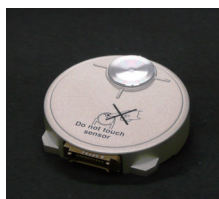

Select receiving element on purchase, automatic recognition.

- UV curing -> UD-T36T2, UD-T40T2, UD-T3040T2
- UV germicidal, Cleaning -> UD-T25T2

Relative spectral sensitivity characteristics

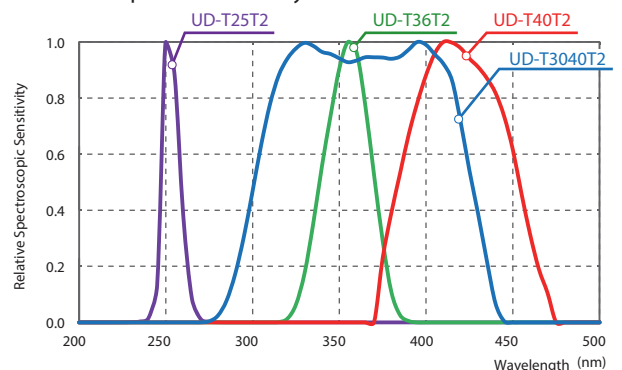

Best for lamp intensity management of the projection exposure machine and a conveyor type

Point 2 Compatible with UV-LED (UD-T3040T2)

These industrial UV checker have a flat spectral response over a wide UV wavelength region, and are capable of measuring the Irradiance of the spectral emission distribution of a light source to be measured.

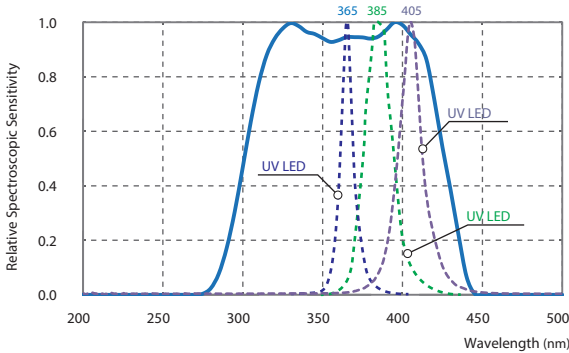

Point 3 One unit 3 way measuring

Versatile enough to measure irradiance (mW/cm²), peak irradiance (mW/cm²), accumulated light amount (mJ/cm²).

Point 4 Improve ease-of-use

Auto mode equipped to be set to the optimal range in accordance with the illumination of the light source.

Point 5 Extension cable (2m)

Handy for using the photodetector and the display unit separately.

Point 6 Memory-Function & USB

Recording and saving illumination profile and analog data to built-in memory or PC.

Data sampling : 50Hz -> About 18 minutes

60Hz -> About 15 minutes

Point 7 USB bus power

Simple built-in by the USB power supply.

Point 8 Correction factor (C.C.F.mode)

Correction to the reference value. Eliminate the error between the device.

Point 9 Warning and alarm temperature over

Warning and alarming to the internal temperature exceeds 60°C the internal temperature will not be available until the 40°C or less. (Internal temperature display)

Point 10 Auto Power-off-Function

Effective / Invalid Change of an Auto Power-Off Function. (5, 10, 15, 30min.)

Point 11 Battery level indicator

In advance to inform the low battery: "BAT"

Point 12 Standard software accessory

Specified number of measurement, Arbitrary interval measurement and calibration numeric or graphical display of measurement data, file output .

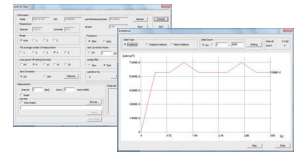

OS	Windows® 10 Pro (32bit / 64bit) Windows® 11 Pro (64bit)
CPU	Intel® Core™ i3 2.4GHz or more
Memory/HDD	1GB or more
Port	USB 2.0 port (One port)
Display	1024x768 or more
Others	CD-ROM Drive

* Windows is trademark and registered trademark by Microsoft Corporation

System diagram / External dimension

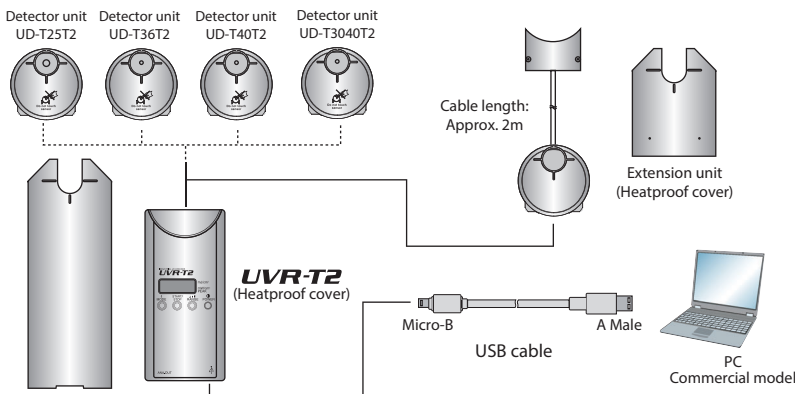

Detector unit types such as UD-T25T2, UD-T36T2, UD-T40T2, UD-T3040T2 are available according to measurable wavelengths range, but the display unit can be used with any of them.

UVR-T2 Accessories

- UVR-T2 main body.....1 pcs.
- Heatproof cover.....1 pcs.
- Screw.....4 pcs.
- Analog output plug.....1 pcs.
- Carrying case.....1 pcs.
- USB cable.....1 pcs.
- CD-ROM (driver/Instruction manual/Measurement program).....1 pcs.

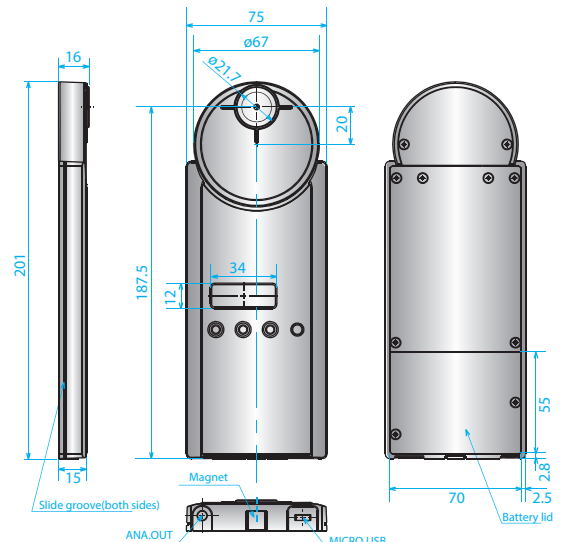

SPECIFICATIONS

Detector unit	UD-T25T2		UD-T36T2		UD-T40T2		UD-T3040T2	
Measurement wavelength range	230 - 280nm		300 - 390nm		350 - 490nm		290 - 430nm	
Peak sensitivity wavelength	Approx.255nm		Approx.355nm		Approx.410nm		-	
Irradiance display (Peak irradiance) mW/cm ²	Range	Measurement range	Range	Measurement range	Range	Measurement range	Range	Measurement range
	1	0.01 - 30.00	1	0.01 - 60.00	1	0.01 - 30.00	1	0.01 - 60.00
	2	0.1 - 300.0	2	0.1 - 600.0	2	0.1 - 300.0	2	0.1 - 600.0
Irradiance (Peak irradiance) mW/cm ²	Range	Measurement range	Range	Measurement range	Range	Measurement range	Range	Measurement range
	1	1.50 - 30.00	1	3.00 - 60.00	1	1.50 - 30.00	1	3.00 - 60.00
	2	15.0 - 300.0	2	30.0 - 600.0	2	15.0 - 300.0	2	30.0 - 600.0
Integral irradiance mJ/cm ²	Range	Measurement range	Range	Measurement range	Range	Measurement range	Range	Measurement range
	1	0.01 - 999.99	1	0.01 - 999.99	1	0.01 - 999.99	1	0.01 - 999.99
	2	0.1 - 9,999.9	2	0.1 - 9,999.9	2	0.1 - 9,999.9	2	0.1 - 9,999.9
Analog output Irradiance for 1mV (Unit : mW/cm ²)	Range	Measurement range	Range	Measurement range	Range	Measurement range	Range	Measurement range
	1	0.015	1	0.03	1	0.015	1	0.03
	2	0.15	2	0.3	2	0.15	2	0.3
Detector element	Silicon photodiode							
Diameter of detector window	ø5mm		ø3mm					
Data sampling	50/60Hz selection type							
	Sampling time (The following table shows the Integral irradiance mode.) 50Hz -> 10ms, 60Hz -> 8.33ms							
	Sampling rate (The following table shows the Integral irradiance mode.) 50Hz -> 50times/sec., 60Hz -> 60times/sec.							
Display	5-digit LCD							
Calibration accuracy	±2% (As to value of calibration reference unit proofread by a standard light source of our company.)							
Linearity	±3% (When there are 5% or more of a full scale quantity of light in each range. And, when zero calibration is done at the instrument startup.)							
Angular incident light characteristics	30° -> Within ±5%, 60° -> Within ±25%							
Analog output voltage	0 - 2.0Vmax. (Common to each range.)							
Interface	USB2.0 (USB A connector - USB Micro B connector)							
Temperature / Humidity characteristics	Within ±4% (10 - 60°C 23°C is standard) / Normal to 85%R.H. (with no dew condensation)							
Power supply	LR03 (Alkaline dry battery) 3 pcs. (not included in the price) / USB bus power							
Operating conditions	Temperature 10 - 60°C / Humidity 85% R.H. or less (No dews)							
Dimensions	Approx.201×75×16mm (Detector unit is mounted/without heatproof cover), Approx.208×83×17mm (Detector unit is mounted/with heatproof cover)							
Weight	Approx.320g (Including the batteries/without heatproof cover), Approx.370g (Including the batteries/with heatproof cover)							
Calibration light source	UD-T25T2 : GL-15 UD-T36T2 : FL-20S-BLB UD-T40T2 / UD-3040T2 : Standard light source A							



JCSS
JCSS 0073

* Some screens are simulated.

* The specifications and external appearances of product in this catalogue may be changed without prior notice due to improvements.

* The catalogue includes products that are sold separately.

* The actual color of products may differ slightly from the catalogue due to lighting and printing conditions.

TechnoOptis Co., Ltd.

formerly Topcon Technohouse Corporation

4F, Imas Itabashi BASE, 2-4-1, Sakashita, Itabashi-ku, TOKYO, 174-0043 JAPAN

Phone: +81-3-3558-2666 Fax: +81-3-3558-4661

E-mail: techno-info@techno-optis.com

SAFETY PRECAUTIONS



Make sure to carefully read the "Manual" to ensure that you use the product properly and safely.

• Always connect the instrument to the specified power supply voltage. Improper connection may cause a fire or electric shock.

• Be sure to use the specified batteries.

Using improper batteries may cause a fire or electric shock.

For more information please visit our website.



<https://www.techno-optis.com/en/>